

**Ewig**  
for import car

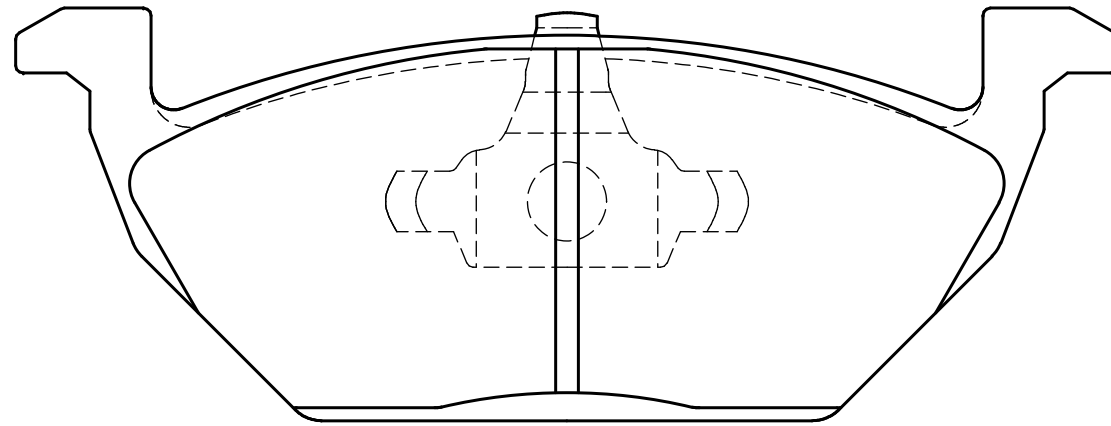

54.6

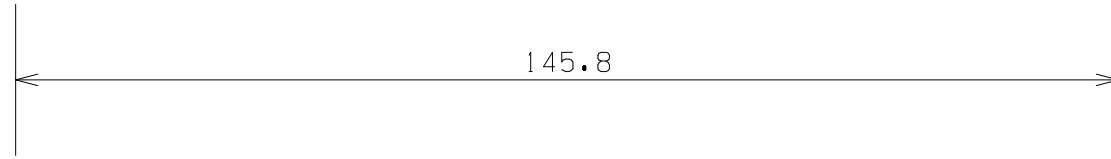

145.8

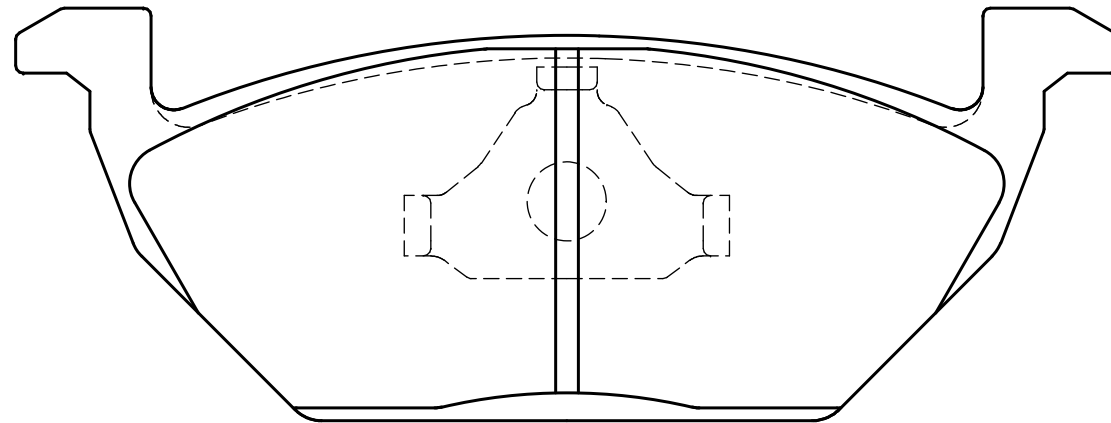

54.6

**Thickness : 19.0**

**Part No : EIP102**